

# AEM33 P 485



## INSTRUCTIONS

### 1 SAFETY

This instrument is manufactured in compliance with EN61010-1 Cat III for nominal operating voltages of 400V L-L and 230V L-N, to ensure safe operation the user must comply with the following instructions:

- Ensure that the supply voltage is correct.
- The auxiliary mains supply is internally fused at 250V, 100mA Type 2. External fusing is required if the auxiliary supply voltage exceeds 250V.
- Maintenance and/or repairs must be carried out only by qualified, authorised personnel.
- If there is ever the suspicion that safe use is no longer possible, the instrument must be disconnected and precautions must be taken against accidental use.
- Operation is no longer safe:
  - 1) If there is clearly visible damage
  - 2) If the instrument no longer functions
  - 3) After prolonged storage in unsuitable conditions.

### 1.1 OPERATOR SAFETY

Read these instructions carefully before installing and utilising the instrument.

The instrument described in this user manual is intended for use by properly trained staff only. Maintenance and/or repairs must be carried out by authorised personnel only. For proper, safe use of the instrument and for maintenance and/or repair, it is essential that the persons instructed to carry out these procedures follow normal safety precautions.

### 2 SYMBOLS

**CAUTION:** Failure to follow the instructions may result in personal injury or damage to equipment.

**NOTE:** Failure to follow the instructions may result in an instrument malfunction.

### 3 CONNECTION DIAGRAMS

#### Standard Connections

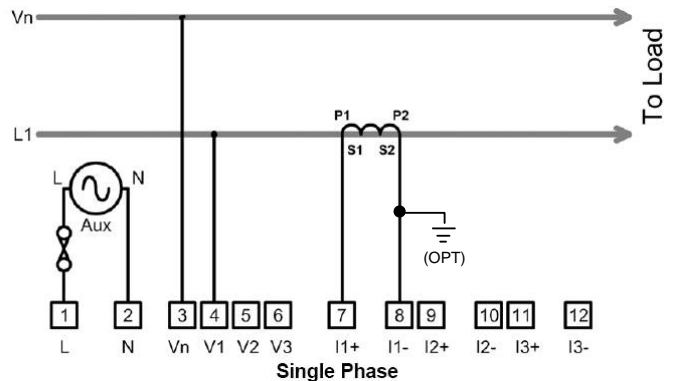
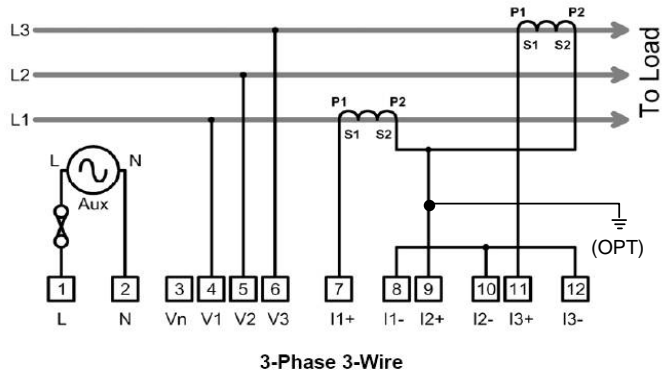
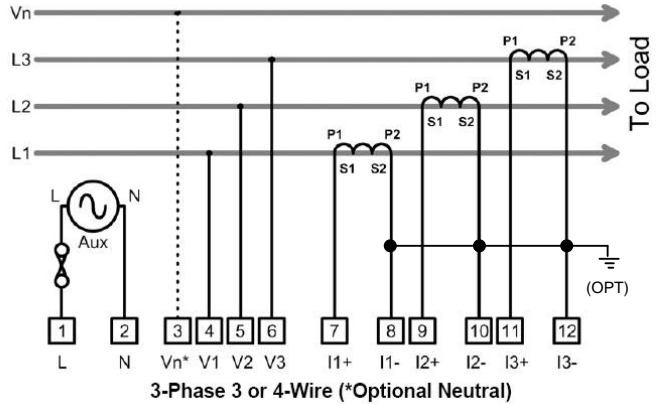

**CAUTION:** The instrument is internally fused at 250V 100mA. External fusing is required if the supply voltage exceeds 250V.

### 3.1 CONNECTION OF THE CURRENT INPUT

The AEM33 is suitable for use with current transformers (CTs) with 5A secondary output. Metering quality CTs of Class 1 accuracy with a minimum rating of 2.5VA are recommended.

Connections should be made according to the diagrams above.

### 3.2 PULSE OUTPUT CONNECTIONS

 **CAUTION:**

The pulse output contacts are rated at 100mA AC/DC, 100V max. Under no circumstances should this rating be exceeded.

The AEM33P is fitted with a single pulse output proportional to kWh. The output has a telltale l.e.d. on the front panel which flashes 'on' to indicated that a pulse has been counted.

The pulse connections are: Terminals 13 & 14

The contacts are volt free and therefore an external power supply must be provided.

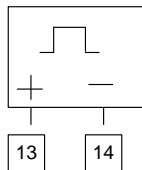

### 3.3 RS485 CONNECTIONS

The RS485 output consists of 3 pairs of terminals located at the bottom left of the rear panel of the instrument. These should be connected via the correct specification cable to the data bus. (Refer to Elcomponent for cable recommendations.)

Terminal connections are as follows:

19 & 20 = A 21 & 22 = B 23 & 24 = 0V

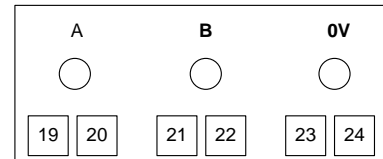

**NOTE:** It is essential that polarity is respected when other units are connected to the bus.

## 4 INSTRUMENT OPERATION & SET-UP

When the instrument is powered up, the display will initially show the internal software version, then after a few seconds will start displaying measured values. The four buttons allow the user to scroll through the available measurements.

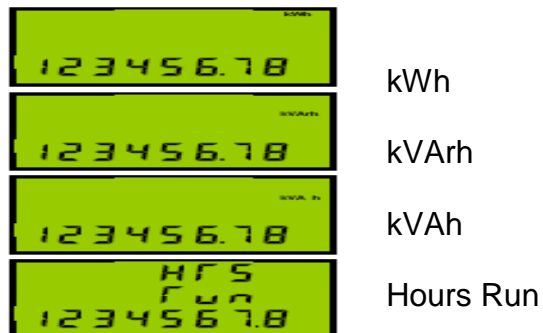

### ENERGY DISPLAYS

Press  to select kWh, kVAh, kVAh and Hours Run pages.



The Hours Run register accumulates the total time during which the average 3 phase load current exceeds a preset level. This is always displayed with a resolution 0.1 hour.

The percentage level of (I1+I2+I3) at which the Hours Run register accumulates is user programmable from 1% to 100% of full scale current.

Press  and  together and hold for 2 seconds to reset the hours run register.

**VOLTAGE DISPLAYS**

Press  to select from the following displays:



**Phase – N**

Voltages 1-3



**Line – Line**

Voltages 1-3



**Max Phase – N**

Voltages 1-3



**Average Phase – N**

Voltages 1-3



**Max Average**

**Phase – N**

Voltages 1-3



**POWER DISPLAYS**

Press  to select from the following displays:

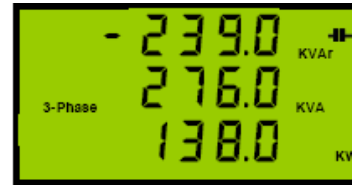

**System Power –  
Reactive, Apparent  
Active**



**NOTE:** The  symbol following the VAR value = capacitive load. A negative indicator before the VAR value indicates exported reactive power.



**Phase Active Power**

1-3

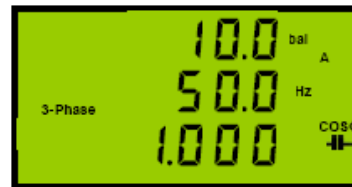

**System**

**Balance Current (I1+I2+I3)**

**Frequency (V1)**

**PF**

**CURRENT DISPLAYS**

Press  to select from the following displays:



**Phase Current**

1-3



**Max Phase  
Current**

1-3



**Average Phase  
Current**

1-3

**Max Average  
Phase Current**

1-3



**NOTE:** The  symbol following the PF value = capacitive load.



**Phase Apparent Power**

1-3



**Phase Reactive Power**

1-3



**NOTE:** The  symbol following the kVAR value = capacitive load.



### Phase PF

1-3



**NOTE:** The  symbol following the Cos value = capacitive load.

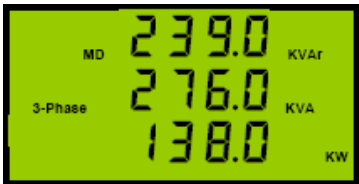

### System Average

### Demand

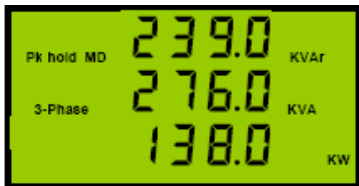

### Rolling average of user defined MD period



### System Max Demand

### Maximum recorded average demand value





## INSTRUMENT SET-UP

To enter programming mode press  and  simultaneously for 5 seconds. The display shows the CT settings screen. The instrument settings are entered from this point, starting with the CT values.

## CT SET-UP

The CT primary value may then be set from the following nominal values (secondary value must be 5A):

- 5, 10, 15, 20, 30, 40, 50, 60, 80, 100, 150, 200, 250, 300, 400, 500, 600, 800, 1000, 1200, 1250, 1500, 1600, 2000, 2400, 3000, 2500, 4000, 4500, 5000, 5500, 6000, 6500, 7000, 7500, 8000, 8500, 9000, 9500, 10000, 10500, 11000, 11500, 12000, 12500, 13000, 13500, 14000, 14500, 15000, 15500, 16000, 16500, 17000, 17500, 18000, 18500, 19000, 19500, 2000, 205000, 21000, 21500, 22500, 23000, 23500, 24000, 24500, 25000



Press the  or  key until the desired current is displayed. If the desired CT value is not present in the above list, the ratio may be 'fine adjusted' as follows: Press and hold the  and  buttons simultaneously for 2 seconds to enter 'Fine Adjust Mode'. This is indicated by the 'L' symbol at the bottom left of the display changing to 'F' (Fine). Find mode allows the CT primary value to be changed in steps of 10A until the desired ratio is displayed. Press the  key to store the value and advance the page.

## VT SET-UP

The default voltage setting is 400V and this value should not be altered unless the meter is an HV type and is connected via voltage transformer(s). In this instance the nominal line to line voltage of the meter must match the secondary voltage of the VT(s) and the voltage is programmed to the *primary* voltage rating of the VT(s)



## MD INTEGRATION PERIOD SET-UP (in Minutes)

This sets the integration period for the sliding window used for MD calculation.

Press the  or  key until the desired value is displayed.

Press the  key to advance the page.



## CURRENT / VOLTAGE AVERAGING PERIOD SET UP

This sets the integration period (in seconds) for the sliding window used for average current and voltage calculations. Press the  or  key until the desired value is displayed.

Press the  key to advance the page.



## HOURS RUN SET-UP

The hours run preset level may be set to any desired kW value.

Press the  or  key until the desired value is displayed.

Press the  key to advance the page.



## PULSE SET-UP

The pulse rate value (PLr) may be set between 0.1 and 100 pulses per unit. Press the  or  key until the desired pulse is displayed. Note that the unit of energy (Wh/kWh/MWh) will automatically change to reflect the primary values of CT & VT previously set. The pulse value is set for both outputs during the process. Press the  key to store the value and advance the page.

The pulse duration value (PLt) may be set in increments between 100mS & 20 seconds as required.



The Pulse Output test allows the meter pulse output and connected data collection hardware to be tested regardless of whether an actual load is present. Press the  button to start the test. The display will show 'run' and the front panel led will flash to verify a pulse is being generated. The display will verify the number of pulses generated.



Press the  button to stop the test.

Press  and  simultaneously to reset the counter.

Press the  key to advance the page.

## RS485 SET-UP

This allows the baud rate and MODBUS address to be set. Use the  and  buttons to set the desired baud rate. Press the  key to store the value and advance the page.

Use the  and  buttons to set the unit address. Press the  key to store the value and save and exit from the set-up menu. The display will show 'storing' to confirm this action.

## 5 TECHNICAL CHARACTERISTICS

**Connection:** 3 Phase 3 or 4 wire Unbalanced, 3 Phase Balanced, Single Phase Load.

**Inputs:** Voltage: 400/230V 3 Phase 3/4 wire  
Current: 5A – External CTs. Fully isolated.

**Burden:** <0.1VA per phase Current/Voltage

**Pulse Output:** Opto isolated volt free contact  
Rating: 100mA ac/dc, 100V ac/dc max  
Value: 1 pulse per kWh  
1 pulse per 10 kWh  
1 pulse per 100 kWh  
1 pulse per 1000 kWh  
Duration: 100ms  
Isolation: 2.5kV for 1 minute

**Power Supply:** 230V 50/60Hz +/- 15%

**Overload:** Voltage x 4 for 1 hour  
Current x 40 for 0.5 seconds max

**Consumption:** 2VA

**Weight:** 325g

**IP Rating:** Instrument = IP20 Front panel = IP40

**Temp Range:** -10° - +65°

**Dims:** 96 x 96 x 83.5

**Accuracy:** kWh: Class 1 EN62053-21 7 BS8431 (2%-120% Nominal Load)

**Environment:** Operate -10°C > T < 65°C. RH < 75% Non-Condensing  
Storage- 25°C > T < 75°C  
IP54 (IP65 with optional kit)

**ELCOMPONENT**  
Making sense of your energy 

Unit 5 Southmill Trading Centre, Southmill Road, Bishop's Stortford,  
Herts. CM23 3DY.

01279 503173 [sales@elcomponent.co.uk](mailto:sales@elcomponent.co.uk)

[www.elcomponent.co.uk](http://www.elcomponent.co.uk)

16.04.15– Issue 5



**NOTE:** Do not expose the instrument display to direct sunlight.